

TAKER B70

480-600 | 480-640 | 480-670

PRODUCT MANUAL

TABLE OF CONTENTS

INTRODUCTION

Taker B70 Reference Guide	3
Physical Characteristics & Warnings	4

BATTERIES

Battery Installation and Replacement	5
Battery Life	6

OPERATION

Operational Modes	6
-------------------	---

FEATURES

Ambidextrous Light Activation	7
Pressure Switch	7
Individual LED Rows	8
Dual Settings	8

WARRANTY

9

CONTACT FOXFURY

10

TAKER B70 REFERENCE GUIDE

LIGHT HEAD (FRONT)

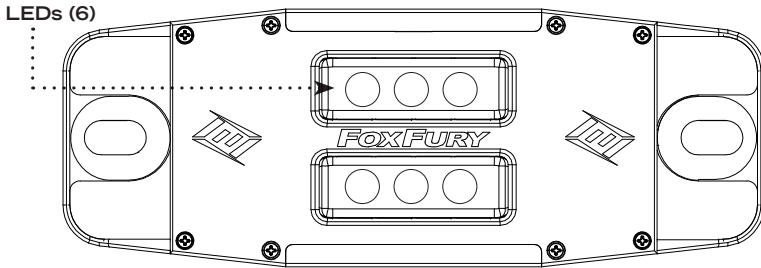

HANDLE (FRONT SIDE)

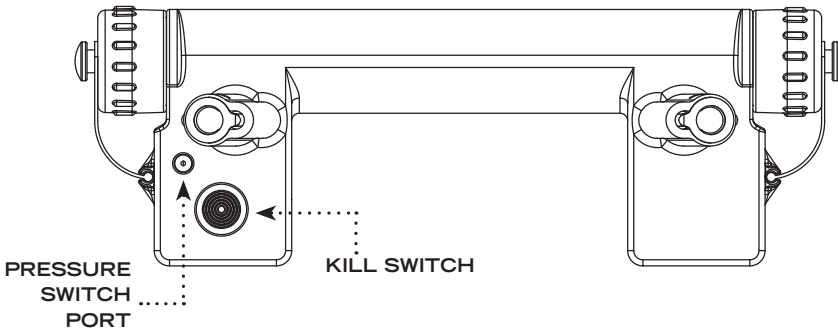

HANDLE (BACK SIDE)

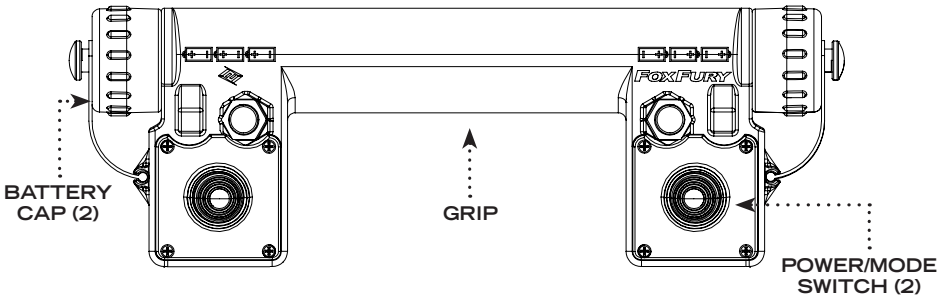

PHYSICAL CHARACTERISTICS

Please read below before using the Taker B70 as it relays beneficial operating and safety information. Please read below before using the Taker B70 as it relays beneficial operating and safety information.



LIGHT HEAD

DIMENSIONS (WxH)	8.1 x 1.1 x 3.0 in (206 x 28 x 76 mm)
WEIGHT	11.64 oz (330 g)

HANDLE

DIMENSIONS (WxH)	9.8 x 3.5 x 3.3 in (250 x 88 x 83 mm)
WEIGHT	10.75 oz (304.8 g)

WARNINGS

-  Do not stare into LEDs for long periods of time or from a close range (less than 2 ft / 0.6 m).
 -  FoxFury's Turbo-Strobe™ is purposely designed to induce disorientation. Prolonged viewing may produce vertigo or even vomiting.
 -  Do NOT attempt to charge the batteries by using the Pressure Switch Port.
-

INCLUDED

-  Taker B70 Shield Light Head
 -  Taker B70 Handle & Pressure Switch
-

BATTERIES

- ❖ The Taker B70 uses three (3) or six (6) CR123 batteries. As long as there are at least three (3) installed, the light will function.
- ❖ Using three (3) CR123 batteries decreases the battery life by half, but does not effect the light intensity.
- ❖ Mixing of new and used, or different brand batteries is not recommended as this could lead to leakage or explosion.

BATTERY INSTALLATION AND REPLACEMENT

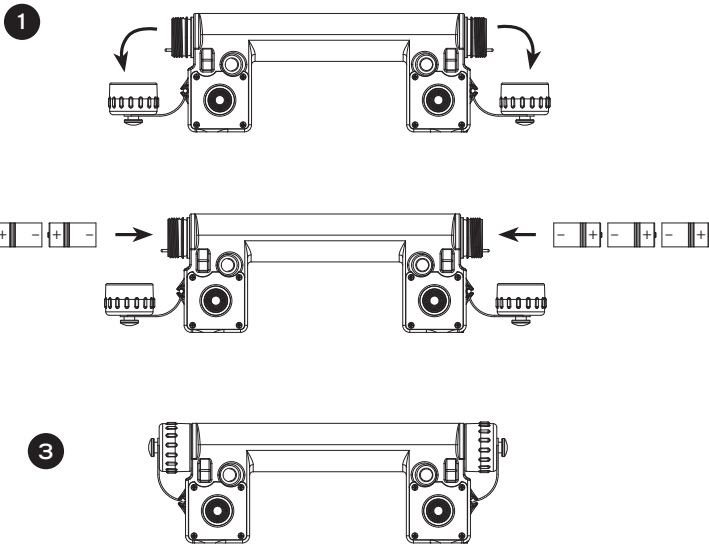

- 1 Twist the Battery Cap (at both ends of the handle) in a counter-clockwise direction to remove them.
- 2 Insert three (3) batteries (with the negative end first) into either side of the handle (respect appropriate polarity when installing).
 - ❖ If installing six (6) batteries (doubling battery life), then repeat step 2 one more time on the opposite side of the handle.
- 3 Re-install the Battery Cap(s) by twisting in a clockwise direction (make sure the Battery Cap(s) are tightly sealed).
 - ❖ Test the light's performance and function by activating the Power/ Mode Switch (located under the Grip).

BATTERY LIFE

MODE	BATTERY LIFE	LUMENS
MOMENTARY	2 hrs	1,200
CONTINUOUS ON	2 hrs	1,200
TURBO-STROBE™	4 hrs	1,200

*Battery life may vary according to mode selected, battery quality and prevailing ambient conditions.

OPERATIONAL MODES

- ❖ For MOMENTARY mode: Press and hold the Power/Mode Switch. While the Switch is depressed, the light will operate continuously. When the user removes pressure from the Switch, the light will turn OFF.
- ❖ For CONTINUOUS ON mode: Press the Power/Mode Switch two (2) times in rapid succession. The light will remain ON.
- ❖ For TURBO-STROBE™: Press the Power/Mode Switch three (3) times in rapid succession.
- ❖ For OFF or EXIT a mode: Press the Power/Mode Switch once. Then, continue following the directions above to progress to desired mode.
- ❖ The Taker B70 has a KILL SWITCH located on the right side of the Handle behind the Power/Mode Switch. This mechanism is a safety precaution to make sure the light does not turn on when not intended to.

NOTE: The light does not retain the mode in memory. Once you turn the light ON, you will have to re-select the mode you desire.

FEATURES

AMBIDEXTROUS LIGHT ACTIVATION

The Taker B70 includes two (2) Power/Mode Switches on both the left and right sides of the Handle. This allows users to toggle between modes using either hand.

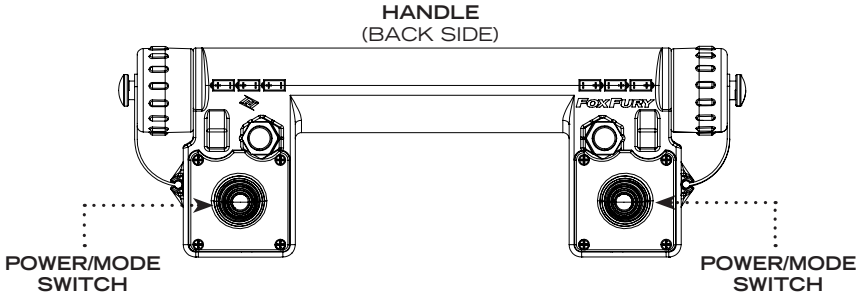

PRESSURE SWITCH (INCLUDED)

The Taker B70 includes a Pressure Switch that allows the user to place it anywhere on the shield. This makes it easier to access the Power/Mode Switch. The Pressure Switch can easily be attached to the shield or Handle via Velcro® or glue.

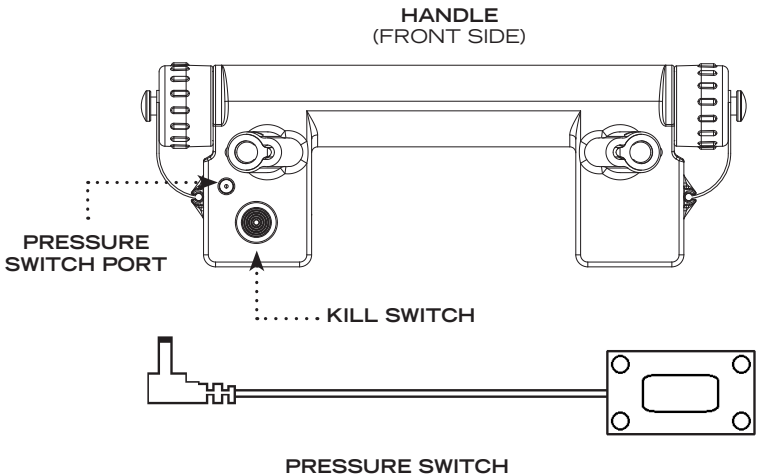

FEATURES (CONT'D)

INDIVIDUAL LED ROWS

The LEDs of the Taker B70 operate on separate circuits, allowing a single row of LEDs to continue functioning if the other row is damaged.

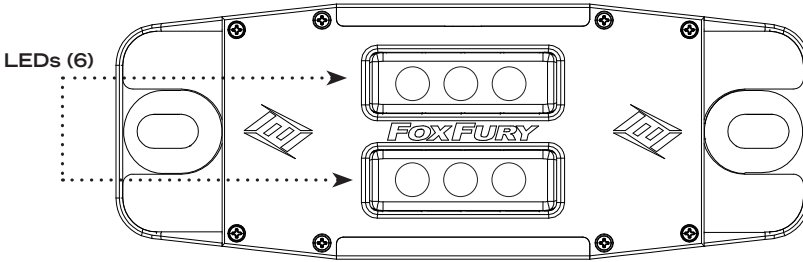

DUAL SETTINGS

The Taker B70 includes two mode settings: the ON/OFF SETTING and the TACTICAL SETTING. The ON/OFF SETTING simply allows the Light Head to turn ON and OFF. The TACTICAL SETTING allows you to choose from three (3) different Operational Modes: Momentary, Continuous On, and Turbo-Strobe™. The Taker B70 is shipped in the TACTICAL SETTING.

To change from the TACTICAL SETTING to the ON/OFF SETTING:

- ❖ With the light turned OFF, press the Power/Mode Switch twice in rapid succession and hold for 10 seconds. The light should begin to flash. Once it begins flashing, it is now in the ON/OFF SETTING.

To change from the ON/OFF SETTING to the TACTICAL SETTING:

- ❖ With the light turned OFF, press and hold the Power/Mode Switch for 10 seconds. The light should begin to go through a slow Turbo-Strobe™ cycle and then turn OFF. It is now in the TACTICAL SETTING.

WARRANTY AND OTHER INFORMATION

PRODUCT DURABILITY



CARE/CLEANING

Your FoxFury product is a professional tool. Regular maintenance and care of your light will maximize performance for you. As needed, wash your FoxFury product using a soft washcloth, clean water and a mild soap. Be sure that all parts are reassembled securely before washing. When done, pat dry with a damp cloth.

WARNINGS

FoxFury, LLC is not responsible for the incorrect use of any FoxFury Lighting product.

- ❖ Lights are strong enough to cause damage to the human eye.
- ❖ Do not stare into LEDs for long periods of time or from a close range (less than 2 ft / 0.6m).
- ❖ FoxFury, LLC is not responsible for any injury or damage caused during the use of this product.
- ❖ Usage of this product must be supervised by an adult when it is being used by a minor.
- ❖ Any FoxFury product should be operated at speeds safe enough to maneuver around surrounding obstacles.
- ❖ Do not use under the influence of drugs or alcohol.

LIMITED LIFETIME WARRANTY

FoxFury, LLC ("FoxFury") warrants this product to be free from defects in material for a lifetime of use except for batteries, LEDs, abuse, and normal wear. We will repair or replace this product should we determine it to be defective. This limited lifetime warranty excludes rechargeable batteries, chargers, switches, and electronics, which have a 2-year warranty with proof of purchase.

This limited lifetime warranty is given only to the original end user of the accompanying product. If you purchased a product from someone other than an authorized FoxFury reseller/distributor or if the product was used, (including but not limited to demo models, show models or refurbished product by someone other than FoxFury) prior to your purchase, you are not the Original Purchaser and the product that you purchased is not covered by this warranty. This limited warranty is VOID if this Product has been altered or modified in any way (including but not limited to attempted warranty repair without authorization from Foxfury and/or alteration/removal of the serial number). To expedite warranty concerns, we encourage the end user to register their FoxFury Product at <https://www.foxfury.com/resources/product-information/product-registration/>.

THIS IS THE ONLY WARRANTY, EXPRESSED OR IMPLIED, INCLUDING ANY WARRANTY OF

MERCHANTABILITY OR FITNESS FOR A PARTICULAR PURPOSE. INCIDENTAL, CONSEQUENTIAL OR SPECIAL DAMAGES ARE EXPRESSLY DISCLAIMED EXCEPT WHERE SUCH LIMITATION IS PROHIBITED BY LAW.

You may have other specific legal rights which vary by jurisdiction. Go to <https://www.foxfury.com/resources/product-information/warranty/> for a complete copy of the warranty. Retain your receipt for proof of purchase.

CONTACT FOXFURY

FoxFury, LLC

Oceanside, CA 92056 USA

Tel: 760.945.4231

Email: service@FoxFury.com

Web: FoxFury.com

All FoxFury products are designed in Oceanside, CA. All FoxFury products are manufactured with the highest quality USA and foreign parts. Products are assembled in either FoxFury's controlled plant in Asia or the USA, under strict quality control.

CALIFORNIA PROPOSITION 65

This product can expose you to chemicals including Lead and DEHP, which are known to the State of California to cause cancer and birth defects or other reproductive harm. For more information go to www.P65Warnings.ca.gov.

