

D10 PARROT ANAFI LIGHTING SYSTEM

P/N 700-314 | P/N 700-316

P/N 700-315 | P/N 700-317

PRODUCT MANUAL

TABLE OF CONTENTS

INTRODUCTION

Overview	3
Physical Characteristics	3
Reference Guide	4 - 5

BATTERY

Charging the Battery	6
----------------------	---

OPERATIONAL MODES

Operational Modes	6
Modes, Output & Battery Life	6

INSTALLATION	7 - 8
---------------------	-------

CARE/CLEANING	9
----------------------	---

WARNINGS/WARRANTY	9
--------------------------	---

CONTACT FOXFURY	10
------------------------	----

OVERVIEW

The D10 Parrot ANAFI Lighting System is a saddle mount and 3 D10 lights that is Made in the USA for the Parrot ANAFI Thermal drone or for the Parrot ANAFI USA drone. The D10's 30° LED operates on continuous or strobe light modes. This rechargeable and splashproof light is durable and compact for a variety of uses where light is needed in a tight space. All 3 lights rotate 360° for optimum light placement.

IMPORTANT!

Please fully charge the D10 before using it for the first time. Please read this manual before using your D10 Parrot ANAFI Lighting System as it relays beneficial operating and safety Information.

PHYSICAL CHARACTERISTICS

D10 Light (White or IR)

DIMENSIONS	1.07 x 0.77 x 1.4 in (27.3 x 19.5 x 36 mm)
WEIGHT	0.42 oz (12 g)

D10 ANAFI Thermal Saddle Mount P/N 85-039

DIMENSIONS	3.35 x 2.26 x 2.33 in (85 x 57.3 x 59.2 mm)
WEIGHT	0.74 oz (21 g)

D10 ANAFI USA Saddle Mount P/N 85-042

DIMENSIONS	4.13 x 2.81 x 2.58 in (105 x 71.5 x 65.5 mm)
WEIGHT	1.27 oz (36 g)

REFERENCE GUIDE

D10 ANAFI LIGHTING SYSTEM

ANAFI THERMAL

P/N 700-314 | P/N 700-316

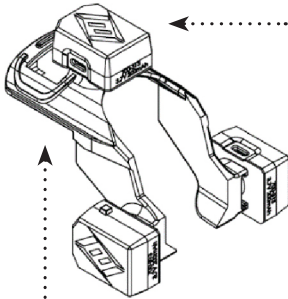

D10 PARROT ANAFI
THERMAL SADDLE

ANAFI USA

P/N 700-315 | P/N 700-317

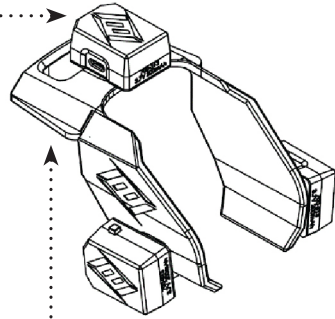

D10 PARROT ANAFI
USA SADDLE

WHAT'S INCLUDED

P/N 700-314 | P/N 700-316

- ❖ D10 White Light (3 ea) for P/N 700-314 **OR**
D10 IR Light (3 ea) for P/N 700-316
- ❖ D10 Parrot ANAFI Thermal Saddle
- ❖ Micro USB Cable (3 ea)

P/N 700-315 | P/N 700-317

- ❖ D10 White Light (3 ea) for P/N 700-315 **OR**
D10 IR Light (3 ea) for P/N 700-317
- ❖ D10 Parrot ANAFI USA Saddle
- ❖ Micro USB Cable (3 ea)

REFERENCE GUIDE

D10 LIGHT

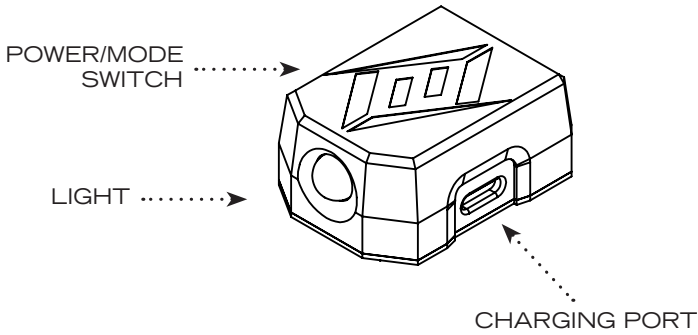

CHARGING PORT



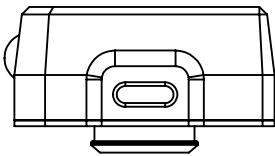

MICRO USB

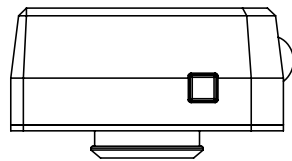

360° SWIVEL



WARNINGS

-  Please fully charge the D10 before using it for the first time.
-  Do not stare into the LEDs for long periods of time or from a close range (less than 2 ft / 0.6 m).
-  While using any FoxFury product, please operate at safe speeds.
-  It is the responsibility of drone/UAV users to follow the FAA and global laws and regulations and/or the laws and regulations applicable to the flight location.

BATTERY

CHARGING THE BATTERY

- ❖ Connect the provided Micro USB Cable to the Charging Port, and to a USB source.
- ❖ While charging, a green light will blink. Once charged, the green light will remain steady on.
- ❖ Charge time should be approximately 1 hour.

WARNING:

Unplug the light once charged to avoid impacting battery life.

If battery is fully discharged because the unit may have not been in use for many months, please charge fully.

OPERATIONAL MODES

OPERATIONAL MODES

- ❖ Press and hold Power/Mode Switch for 3 seconds to turn light ON.
- ❖ For IR version, the green light will blink once before turning on the invisible light.
- ❖ Press Power/Mode Switch again to turn the light to STROBE.
- ❖ For IR, the green light will blink twice before the light output is in strobe mode.
- ❖ Press the Power/Mode Switch again to turn light OFF. For IR, the green light will blink three times before turning OFF.

MODE	WHITE LUMENS	IR mW	BATTERY LIFE
ON	200	400	30 - 40 minutes
STROBE	200	400	60 - 80 minutes

INSTALLATION

- 1 Align the bottom of the D10 light with Saddle snap lock location and snap all D10 units in place. Spin them and tug to make sure they are properly attached.

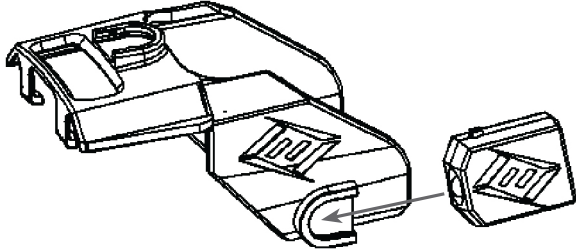

- 2 Take the Saddle with lights installed, and mount on the ANAFI, as shown below (lights are removed for simplicity).

Hook the two teeth to the underside of the top cover on the ANAFI (behind the camera) as shown.

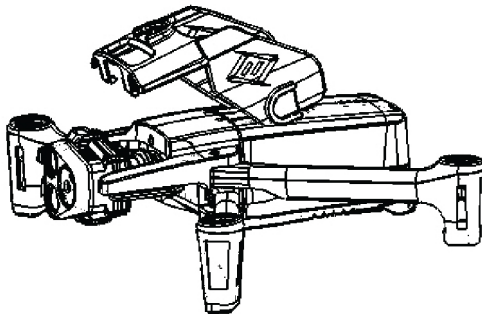

INSTALLATION

- 3 Press down on the body. The Saddle side arms will spread and hug the belly of the ANAFI.

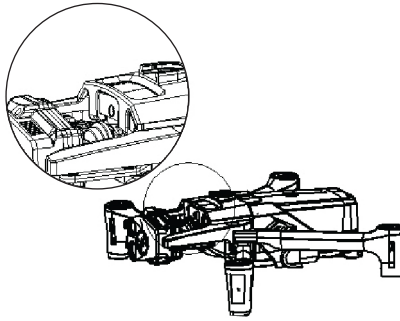

The Saddle should feel snug as it wraps around the body.

NOTE: Do not pull/spread the Saddle during the installation. The Saddle is intended to be pushed into place.

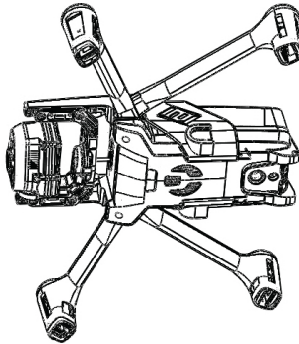

NOTE: When recharging D10 lights, they can either be removed from the Saddle or remain installed.

NOTE:

Before our accessories are made available, they are tested internally and verified externally by a minimum of 2 professional users. We have experienced multiple cases of UAS (drone) mechanical modifications from manufacturers within the same P/N and revision, and without providing warnings or product updates. If there is a fit problem, please contact our customer service department at <https://www.foxfury.com/contact/>

WARRANTY AND OTHER INFORMATION

PRODUCT DURABILITY



PRODUCT NAME & PART NUMBER:

D10 ANAFI Thermal Lighting System
P/N: 700-314 (WHITE) & 700-316 (IR)

D10 ANAFI USA Lighting System
P/N: 700-315 (WHITE) & 700-317 (IR)

CARE/CLEANING



Your FoxFury product is a professional tool. Regular maintenance and care of your light will maximize performance for you. As needed, clean your FoxFury product using a damp soft washcloth. Do not immerse.



ACCESSORIES

 D Series Mount Set, P/N 850-730

WARNINGS

FoxFury, LLC is not responsible for the incorrect use of any FoxFury Lighting product.

-  Lights are strong enough to cause damage to the human eye.
-  Do not stare into LEDs for long periods of time or from a close range (less than 2 ft / 0.6 m).
-  FoxFury, LLC is not responsible for any injury or damage caused during the use of this product.

-  Usage of this product must be supervised by an adult when it is being used by a minor.
-  Any FoxFury product should be operated at speeds safe enough to maneuver around surrounding obstacles.
-  Do not use under the influence of drugs or alcohol.

ONE YEAR WARRANTY

FoxFury, LLC (“FoxFury”) warrants this product to be free from defects in material for one year after purchase. LiPo batteries have a one year pro-rated or 300 re-charge cycle pro-rated warranty, whichever the user reaches first.

This warranty is given only to the original end user of the accompanying product. If you purchased a product from someone other than an authorized FoxFury reseller/distributor or if the product was used, (including but not limited to demo models, show models or refurbished product by someone other than FoxFury) prior to your purchase, you are not the Original Purchaser and the product that you purchased is not covered by this warranty. This warranty is VOID if this Product has been altered or modified in any way (including but not limited to attempted warranty repair without authorization from FoxFury and/or alteration/removal of the serial number). To expedite warranty concerns, we encourage the end user to register their FoxFury Product at www.foxfury.com/pages/warranty-registration.

THIS IS THE ONLY WARRANTY,
EXPRESSED OR IMPLIED,
INCLUDING ANY WARRANTY OF
MERCHANTABILITY OR FITNESS
FOR A PARTICULAR PURPOSE.
INCIDENTAL, CONSEQUENTIAL
OR SPECIAL DAMAGES ARE
EXPRESSLY DISCLAIMED EXCEPT
WHERE SUCH LIMITATION IS
PROHIBITED BY LAW.

You may have other specific legal
rights which vary by jurisdiction. Go to
www.foxfury.com/pages/warranty for a
complete copy of the warranty. Retain
your receipt for proof of purchase.

CONTACT FOXFURY

FoxFury, LLC
Oceanside, CA 92056 USA

Toll-Free: 844-FOXFURY

Tel: 760.945.4231

Fax: 760.433.3650

Email: service@FoxFury.com

Web: FoxFury.com

All FoxFury products are designed in
Oceanside, CA. All FoxFury products
are manufactured with the highest
quality USA and foreign parts.
Products are assembled in either
FoxFury's controlled plant in Asia or the
USA, under strict quality control.

CALIFORNIA PROPOSITION 65

This product can expose you to
chemicals including Lead and DEHP,
which are known to the State of
California to cause cancer and
birth defects or other reproductive
harm. For more information go to
www.P65Warnings.ca.gov.

